

1200 V, 30 A ultrafast high voltage diode

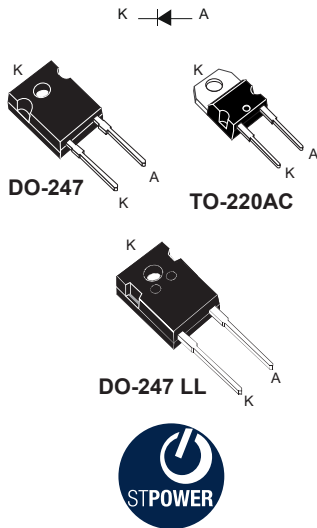

Features

- Ultrafast, soft recovery
- Low leakage current
- Very low conduction and switching losses
- High frequency and/or high pulsed current operation
- High reverse voltage capability
- High junction temperature capability
- ECOPACK2 compliant

Applications

- AC-DC converter
- DC-DC stage in power supply
- DC-AC converter
- Solar inverters
- EV charging station
- Telecom power supply
- UPS

Product status link

[STTH3012](#)

Product summary

$I_{F(AV)}$	30 A
V_{RRM}	1200 V
$V_F(\text{typ.})$	1.30 V
$t_{rr}(\text{typ.})$	48 ns
$T_j(\text{max.})$	175 °C

Description

The high-quality design of this diode has produced a device with low leakage current, regularly reproducible characteristics, and intrinsic ruggedness. These characteristics make it ideal for heavy-duty applications that demand long-term reliability.

Such demanding applications include industrial power supplies, motor control, and similar mission-critical systems that require rectification and freewheeling. These diodes also fit into auxiliary functions such as snubber, bootstrap, and demagnetization applications.

The improved performance in low leakage current, and therefore thermal runaway guard band, is an immediate competitive advantage for this device.

1 Characteristics

Table 1. Absolute ratings (limiting values, at 25 °C, unless otherwise specified)

Symbol	Parameter		Value	Unit	
V_{RRM}	Repetitive peak reverse voltage		1200	V	
$I_{F(RMS)}$	Forward rms current		50	A	
$I_{F(AV)}$	Average forward current	DO-247	$T_C = 140\text{ °C}$, $\delta = 0.5$ square	30	A
		DO-247 LL	$T_C = 135\text{ °C}$, $\delta = 0.5$ square		
		TO-220AC	$T_C = 130\text{ °C}$, $\delta = 0.5$ square		
I_{FSM}	Surge non repetitive forward current		$t_p = 10$ ms sinusoidal	210	A
T_{stg}	Storage temperature range		-65 to +175	°C	
T_j	Maximum operating junction temperature		175	°C	

Table 2. Thermal parameters

Symbol	Parameter		Typ.	Max.	Unit
$R_{th(j-c)}$	Junction to case	DO247	0.36	0.51	°C/W
		DO247-LL	0.37	0.53	
		TO-220AC	0.44	0.62	

For more information, please refer to the following application note:

- AN5088: Rectifiers thermal management, handling and mounting recommendation

Table 3. Static electrical characteristics

Symbol	Parameter	Test conditions		Min.	Typ.	Max.	Unit
$I_R^{(1)}$	Reverse leakage current	$T_j = 25\text{ °C}$	$V_R = V_{RRM}$	-		20	μA
		$T_j = 125\text{ °C}$		-	15	150	
$V_F^{(2)}$	Forward voltage drop	$T_j = 25\text{ °C}$	$I_F = 30\text{ A}$	-		2.25	V
		$T_j = 125\text{ °C}$		-	1.35	2.05	
		$T_j = 150\text{ °C}$		-	1.30	1.95	

1. Pulse test: $t_p = 5\text{ ms}$, $\delta < 2\%$

2. Pulse test: $t_p = 380\text{ }\mu\text{s}$, $\delta < 2\%$

To evaluate the conduction losses, use the following equation:

$$P = 1.60 \times I_{F(AV)} + 0.012 \times I_{F(RMS)}^2$$

For more information, please refer to the following application notes related to the power losses:

- AN604: Calculation of conduction losses in a power rectifier
- AN4021: Calculation of reverse losses on a power diode

Table 4. Dynamic electrical characteristics

Symbol	Parameter	Test conditions		Min.	Typ.	Max.	Unit
$t_{rr}^{(1)}$	Reverse recovery time	$T_J = 25\text{ }^\circ\text{C}$	$I_F = 1\text{ A}, V_R = 30\text{ V}, di_F/dt = -50\text{ A}/\mu\text{s}$	-		115	ns
			$I_F = 1\text{ A}, V_R = 30\text{ V}, di_F/dt = -100\text{ A}/\mu\text{s}$	-	57	80	
			$I_F = 1\text{ A}, V_R = 30\text{ V}, di_F/dt = -200\text{ A}/\mu\text{s}$		48		
$I_{RM}^{(1)}$	Reverse recovery current	$T_J = 125\text{ }^\circ\text{C}$	$I_F = 60\text{ A}, V_R = 600\text{ V}, di_F/dt = 200\text{ A}/\mu\text{s}$	-	25	35	A
$Q_{RR}^{(1)}$	Reverse recovery charge			-	5700		nC

1. Measurements taken at 10% of I_{RM} , $S = tb/ta$

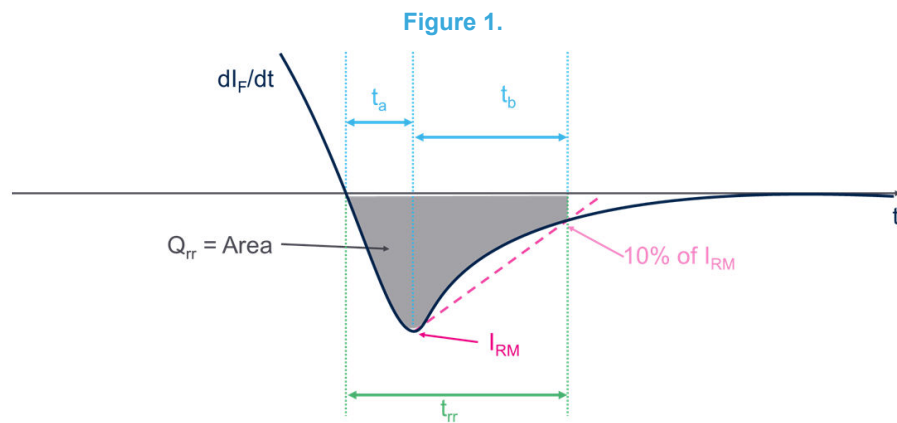

1.1 Characteristics (curves)

Figure 2. Conduction losses versus average current

Figure 3. Forward voltage drop versus forward current

Figure 4. Relative variation of thermal impedance junction to case versus pulse duration

Figure 5. Peak reverse recovery current versus di_F/dt (typical values)

Figure 6. Reverse recovery time versus di_F/dt (typical values)

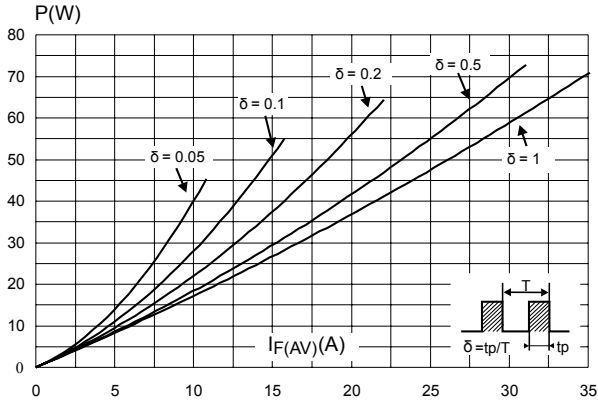
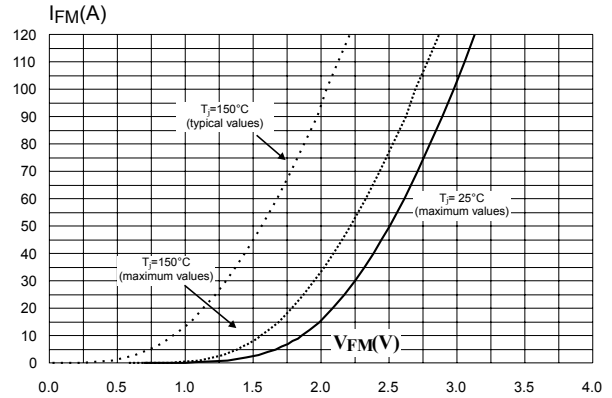
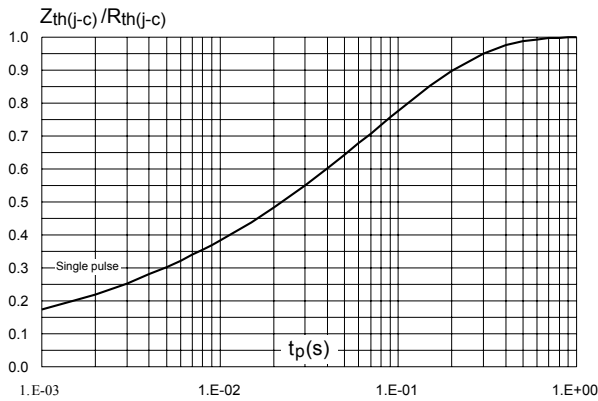
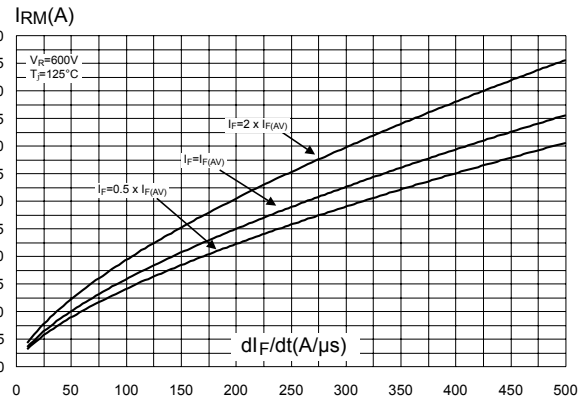
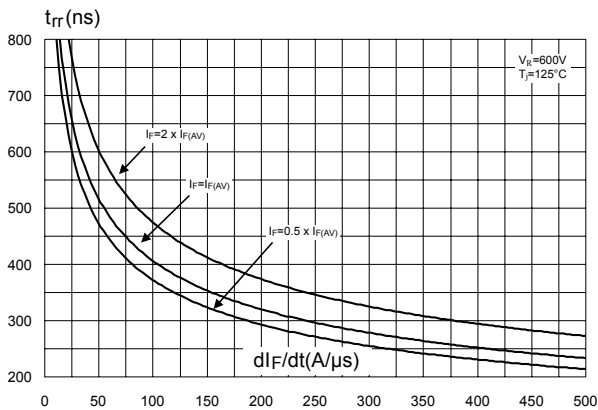
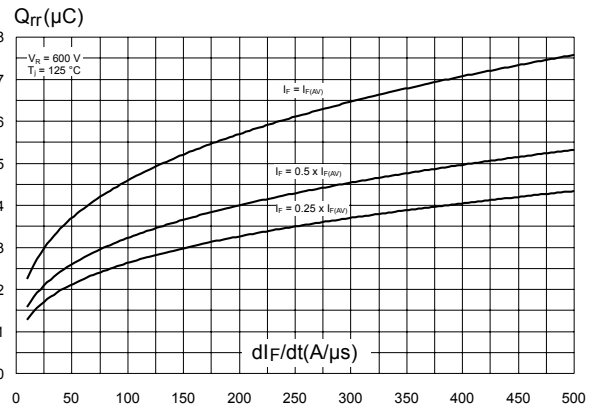
Figure 7. Reverse recovery charges versus di_F/dt (typical values)

Figure 8. Softness factor versus di_F/dt (typical values)

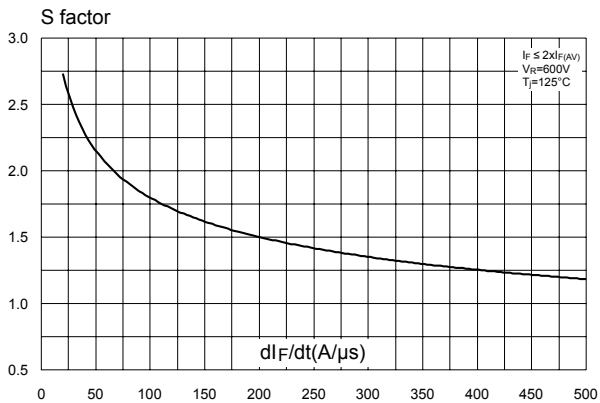

Figure 9. Relative variations of dynamic parameters versus junction temperature

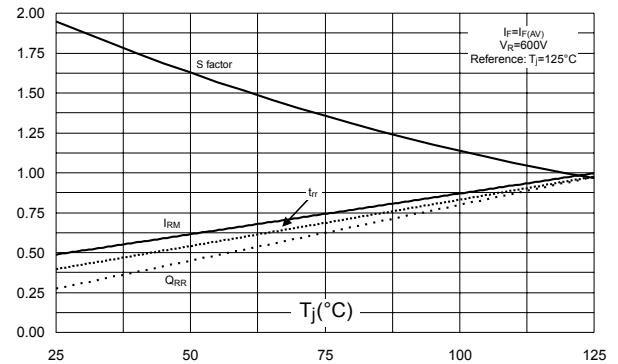

Figure 10. Transient peak forward voltage versus di_F/dt (typical values)

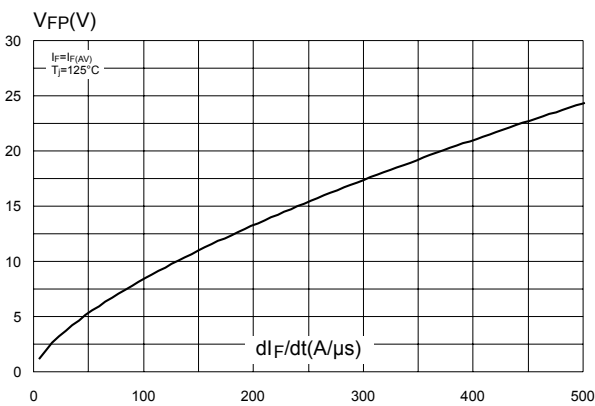

Figure 11. Forward recovery time versus di_F/dt (typical values)

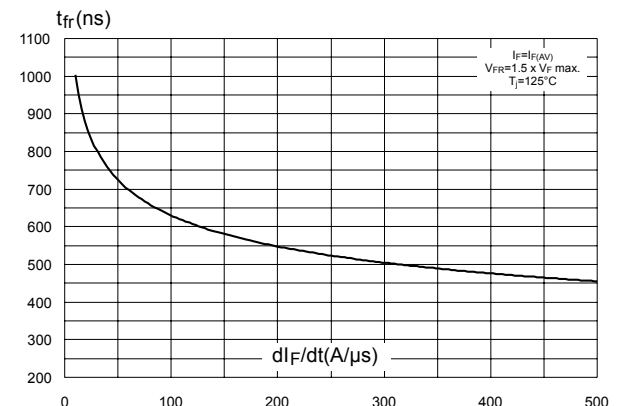
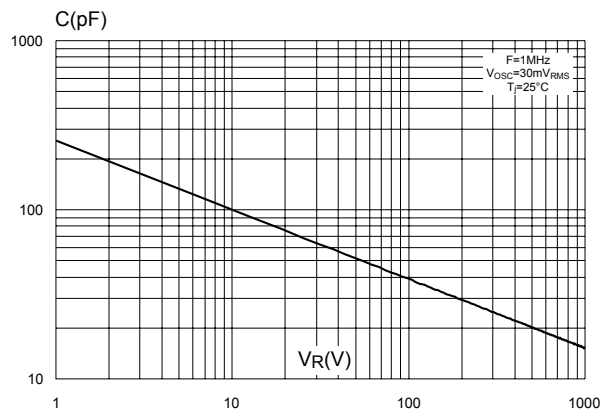

Figure 12. Junction capacitance versus reverse voltage applied (typical values)



2 Package information

In order to meet environmental requirements, ST offers these devices in different grades of **ECOPACK** packages, depending on their level of environmental compliance. ECOPACK specifications, grade definitions and product status are available at: www.st.com. ECOPACK is an ST trademark.

2.1 DO-247 package information

- Epoxy meets UL94, V0
- Cooling method: by conduction (C)
- Recommended torque value: 0.8 N·m
- Maximum torque value: 1.0 N·m

Figure 13. DO-247 package outline

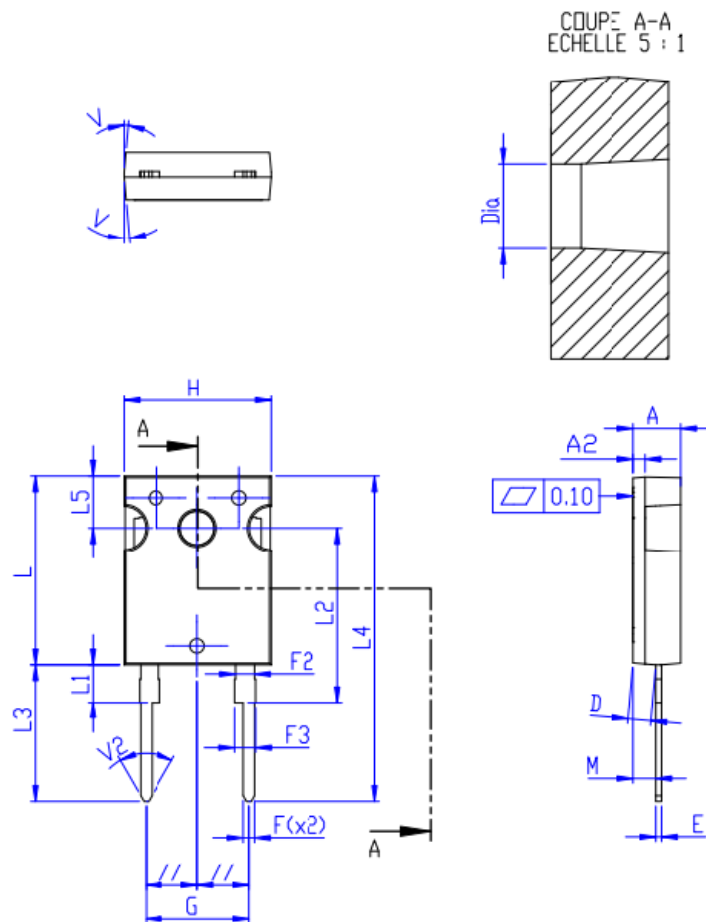

Table 5. DO-247 package mechanical data

Ref.	Dimensions					
	Millimeters			Inches (for reference only)		
	Min.	Typ.	Max.	Min.	Typ.	Max.
A	4.90		5.10	0.1920		0.2010
A2	1.17		1.37	0.0460		0.0540
D	2.2		2.6	0.0866		0.1023
E	0.4		0.8	0.0157		0.0314
F	1		1.4	0.0393		0.0551
F2		2			0.0787	
F3	2		2.4	0.0787		0.0944
G		10.9			0.4291	
H	15.45		15.75	0.6082		0.6200
L	19.85		20.15	0.7814		0.7933
L1	3.7		4.3	0.1456		0.1692
L2		18.5			0.7283	
L3	14.2		14.8	0.5590		0.5826
L4		34.6			1.3622	
L5		5.5			0.2165	
M	2		3	0.0787		0.1181
V		5°			5°	
V2		60°			60°	
Diam.	3.55		3.65	0.1397		0.1437

2.2 TO-220AC package information

- Epoxy meets UL 94, V0
- Cooling method: by conduction (C)
- Recommended torque value: 0.55 N·m
- Maximum torque value: 0.70 N·m

Figure 14. TO-220AC package outline

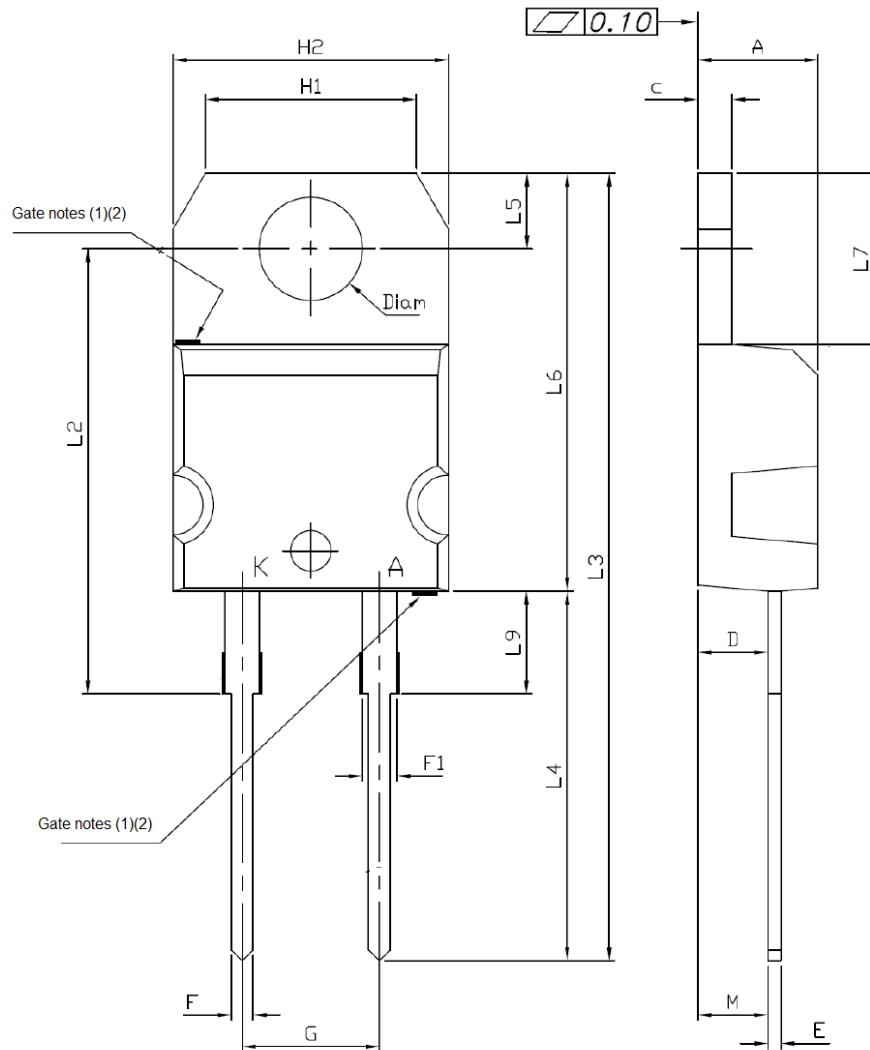

- (1) : Max resin gate protusion 0.5 mm
 (2) : Resin gate position is accepted in each of the two positions shown on the drawings or their symmetrical

Note: This package drawing may slightly differ from the physical package. However, all the specified dimensions are guaranteed.

Table 6. TO-220AC package mechanical data

Ref.	Dimensions					
	Millimeters			Inches (for reference only)		
	Min.	Typ.	Max.	Min.	Typ.	Max.
A	4.40		4.60	0.173		0.181
C	1.23		1.32	0.048		0.051
D	2.40		2.72	0.094		0.107
E	0.49		0.70	0.019		0.027
F	0.61		0.88	0.024		0.034
F1	1.14		1.70	0.044		0.066
G	4.95		5.15	0.194		0.202
H2	10.00		10.40	0.393		0.409
L2		16.40			0.645	
L4	13.00		14.00	0.511		0.551
L5	2.65		2.95	0.104		0.116
L6	15.25		15.75	0.600		0.620
L7	6.20		6.60	0.244		0.259
L9	3.50		3.93	0.137		0.154
M		2.60			0.102	
Diam	3.75		3.85	0.147		0.151
Slug flatness		0.03	0.10		0.001	0.004

2.3 DO-247 LL package information

- Epoxy meets UL94, V0
- Cooling method: by conduction (C)
- Recommended torque value: 0.8 N·m
- Maximum torque value: 1.0 N·m

Figure 15. DO-247 LL package outline

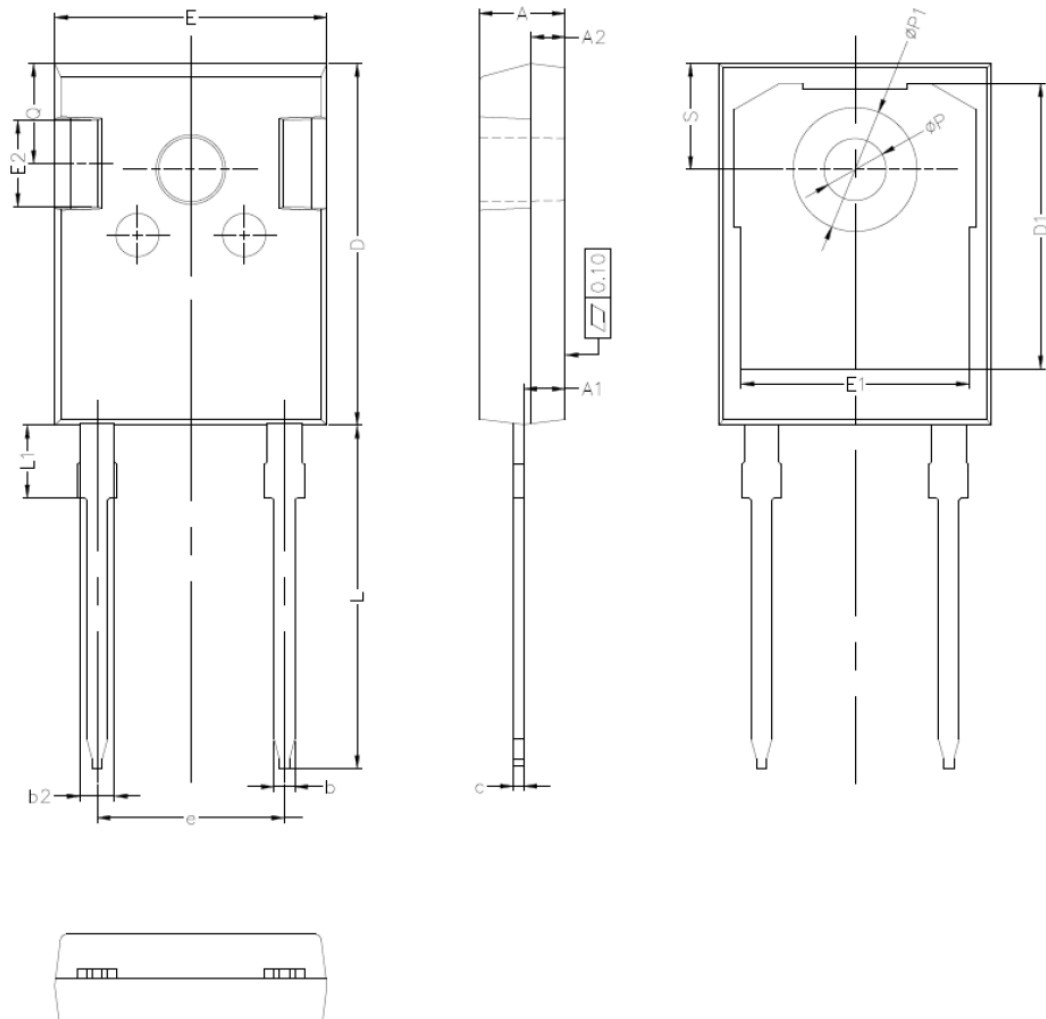

Note: This package drawing may slightly differ from the physical package. However, all the specified dimensions are guaranteed.

Table 7. DO-247 LL package mechanical data

Ref.	Dimensions			
	Millimeters		Inches (for reference only)	
	Min.	Max.	Min.	Max.
A	4.70	5.31	0.185	0.209
A1	2.21	2.59	0.087	0.102
A2	1.50	2.49	0.059	0.098
b	0.99	1.40	0.039	0.055
b2	1.65	2.39	0.065	0.094
c	0.38	0.89	0.015	0.035
D	20.80	21.46	0.819	0.845
D1	13.08		0.515	
E	15.49	16.26	0.610	0.640
e	10.88 typ.		0.428	
E1	13.06		0.514	
E2	3.43	5.10	0.135	0.200
L	19.80	20.32	0.779	0.800
L1		4.50		0.177
P	3.50	3.70	0.137	0.146
P1	7.00	7.40	0.275	0.292
Q	5.38	6.20	0.219	0.244
S	6.16 typ.		0.243	

3 Ordering information

Table 8. Ordering information

Order code	Marking	Package	Weight	Base qty.	Delivery mode
STTH3012D	STTH3012D	TO-220AC	1.86 g	50	Tube
STTH3012W	STTH3012W	DO-247	4.40 g	30	Tube
STTH3012WL	STTH3012WL	DO-247 LL	5.90 g	30	Tube

Revision history

Table 9. Document revision history

Date	Revision	Changes
02-Mar-2006	1	First issue.
17-May-2022	2	Added DO-247-LL package information. Minor text changes.
07-Dec-2023	3	Updated Table 4 , and Figure 7 .

IMPORTANT NOTICE – READ CAREFULLY

STMicroelectronics NV and its subsidiaries (“ST”) reserve the right to make changes, corrections, enhancements, modifications, and improvements to ST products and/or to this document at any time without notice. Purchasers should obtain the latest relevant information on ST products before placing orders. ST products are sold pursuant to ST’s terms and conditions of sale in place at the time of order acknowledgment.

Purchasers are solely responsible for the choice, selection, and use of ST products and ST assumes no liability for application assistance or the design of purchasers’ products.

No license, express or implied, to any intellectual property right is granted by ST herein.

Resale of ST products with provisions different from the information set forth herein shall void any warranty granted by ST for such product.

ST and the ST logo are trademarks of ST. For additional information about ST trademarks, refer to www.st.com/trademarks. All other product or service names are the property of their respective owners.

Information in this document supersedes and replaces information previously supplied in any prior versions of this document.

© 2023 STMicroelectronics – All rights reserved