

CoolMOS™ Power Transistor
Features

- New revolutionary high voltage technology
- Intrinsic fast-recovery body diode
- Extremely low reverse recovery charge
- Ultra low gate charge
- Extreme dv/dt rated
- High peak current capability
- Periodic avalanche rated
- Qualified according to JEDEC⁰⁾ for target applications
- Pb-free lead plating; RoHS compliant

Product Summary

V_{DS}	600	V
$R_{DS(on),max}$	0.22	Ω
$I_D^{1)}$	20.7	A

PG-TO220-3-31

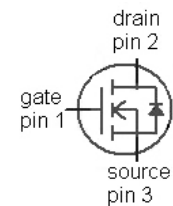
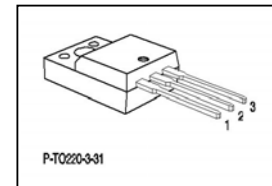

Type	Package	Ordering Code	Marking
SPA20N60CFD	PG-TO220-3-31	SP000216361	20N60CFD

Maximum ratings, at $T_j=25\text{ °C}$, unless otherwise specified

Parameter	Symbol	Conditions	Value	Unit
Continuous drain current ¹⁾	I_D	$T_C=25\text{ °C}$	20.7	A
		$T_C=100\text{ °C}$	13.1	
Pulsed drain current ²⁾	$I_{D,pulse}$	$T_C=25\text{ °C}$	52	
Avalanche energy, single pulse	E_{AS}	$I_D=10\text{ A}$, $V_{DD}=50\text{ V}$	690	mJ
Avalanche energy, repetitive $t_{AR}^{2),3)}$	E_{AR}	$I_D=20\text{ A}$, $V_{DD}=50\text{ V}$	1	
Avalanche current, repetitive $t_{AR}^{2),3)}$	I_{AR}		20	A
Drain source voltage slope	dv/dt	$I_D=20.7\text{ A}$, $V_{DS}=480\text{ V}$, $T_j=125\text{ °C}$	80	V/ns
Reverse diode dv/dt	dv/dt	$I_S=20.7\text{ A}$, $V_{DS}=480\text{ V}$, $T_j=125\text{ °C}$	40	V/ns
Maximum diode commutation speed	di/dt	$T_j=125\text{ °C}$	900	A/ μ s
Gate source voltage	V_{GS}	static	± 20	V
		AC ($f > 1\text{ Hz}$)	± 30	
Power dissipation	P_{tot}	$T_C=25\text{ °C}$	35	W
Operating and storage temperature	T_j , T_{stg}		-55 ... +150	$^{\circ}\text{C}$

Parameter	Symbol	Conditions	Values			Unit
			min.	typ.	max.	

Thermal characteristics

Thermal resistance, junction - case	R_{thJC}		-	-	3.6	K/W
Thermal resistance, junction - ambient	R_{thJA}	leaded	-	-	62	
Soldering temperature, wave soldering	T_{sold}	1.6 mm (0.063 in.) from case for 10 s	-	-	260	°C

Electrical characteristics, at $T_j=25\text{ °C}$, unless otherwise specified

Static characteristics

Drain-source breakdown voltage	$V_{(BR)DSS}$	$V_{GS}=0\text{ V}$, $I_D=250\text{ }\mu\text{A}$	600	-	-	V
Avalanche breakdown voltage	$V_{(BR)DS}$	$V_{GS}=0\text{ V}$, $I_D=20\text{ A}$	-	700	-	
Gate threshold voltage	$V_{GS(th)}$	$V_{DS}=V_{GS}$, $I_D=1000\mu\text{A}$	3	4	5	
Zero gate voltage drain current	I_{DSS}	$V_{DS}=600\text{ V}$, $V_{GS}=0\text{ V}$, $T_j=25\text{ °C}$	-	2.1	-	μA
		$V_{DS}=600\text{ V}$, $V_{GS}=0\text{ V}$, $T_j=150\text{ °C}$	-	1700	-	
Gate-source leakage current	I_{GSS}	$V_{GS}=20\text{ V}$, $V_{DS}=0\text{ V}$	-	-	100	nA
Drain-source on-state resistance	$R_{DS(on)}$	$V_{GS}=10\text{ V}$, $I_D=13.1\text{ A}$, $T_j=25\text{ °C}$	-	0.19	0.22	Ω
		$V_{GS}=10\text{ V}$, $I_D=13.1\text{ A}$, $T_j=150\text{ °C}$	-	0.43	-	
Gate resistance	R_G	$f=1\text{ MHz}$, open drain	-	0.54	-	
Transconductance	g_{fs}	$ V_{DS} >2 I_D R_{DS(on)max}$, $I_D=13.1\text{ A}$	-	17.5	-	S

Parameter	Symbol	Conditions	Values			Unit
			min.	typ.	max.	

Dynamic characteristics

Input capacitance	C_{iss}	$V_{GS}=0\text{ V}, V_{DS}=25\text{ V},$ $f=1\text{ MHz}$	-	2400	-	pF
Output capacitance	C_{oss}		-	780	-	
Reverse transfer capacitance	C_{rss}		-	50	-	
Effective output capacitance, energy related ⁴⁾	$C_{o(er)}$	$V_{GS}=0\text{ V}, V_{DS}=0\text{ V}$ to 480 V	-	83	-	
Effective output capacitance, time related ⁵⁾	$C_{o(tr)}$		-	160	-	
Turn-on delay time	$t_{d(on)}$	$V_{DD}=380\text{ V},$ $V_{GS}=10\text{ V}, I_D=20.7\text{ A},$ $R_G=3.6\ \Omega$	-	12	-	ns
Rise time	t_r		-	15	-	
Turn-off delay time	$t_{d(off)}$		-	59	-	
Fall time	t_f		-	6.4	-	

Gate Charge Characteristics

Gate to source charge	Q_{gs}	$V_{DD}=480\text{ V},$ $I_D=20.7\text{ A},$ $V_{GS}=0\text{ to }10\text{ V}$	-	15	-	nC
Gate to drain charge	Q_{gd}		-	54	-	
Gate charge total	Q_g		-	95	124	
Gate plateau voltage	$V_{plateau}$		-	7.0	-	V

⁰⁾ J-STD20 and JESD22

¹⁾ Limited only by maximum temperature.

²⁾ Pulse width t_p limited by $T_{j,max}$

³⁾ Repetitive avalanche causes additional power losses that can be calculated as $P_{AV}=E_{AR} \cdot f$.

⁴⁾ $C_{o(er)}$ is a fixed capacitance that gives the same stored energy as C_{oss} while V_{DS} is rising from 0 to 80% V_{DSS} .

⁵⁾ $C_{o(tr)}$ is a fixed capacitance that gives the same charging time as C_{oss} while V_{DS} is rising from 0 to 80% V_{DSS} .

Parameter	Symbol	Conditions	Values			Unit
			min.	typ.	max.	
Reverse Diode						
Diode continuous forward current ¹⁾	I_S	$T_C=25\text{ }^\circ\text{C}$	-	-	20.7	A
Diode pulse current ²⁾	$I_{S,pulse}$		-	-	52	
Diode forward voltage	V_{SD}	$V_{GS}=0\text{ V}, I_F=20.7\text{ A}, T_j=25\text{ }^\circ\text{C}$	-	1.0	1.2	V
Reverse recovery time	t_{rr}	$V_R=480\text{ V}, I_F=I_S, di_F/dt=100\text{ A}/\mu\text{s}$	-	150	-	ns
Reverse recovery charge	Q_{rr}		-	1	-	μC
Peak reverse recovery current	I_{rrm}		-	13	-	A

Typical Transient Thermal Characteristics

Symbol	Value	Unit	Symbol	Value	Unit
	typ.			typ.	
R_{th1}	0.00862	K/W	C_{th1}	0.000205	Ws/K
R_{th2}	0.0471		C_{th2}	0.00198	
R_{th3}	0.119		C_{th3}	0.0068	
R_{th4}	0.476		C_{th4}	0.0482	
R_{th5}	1.57		C_{th5}	0.957	
			C_{th6}	0.1	

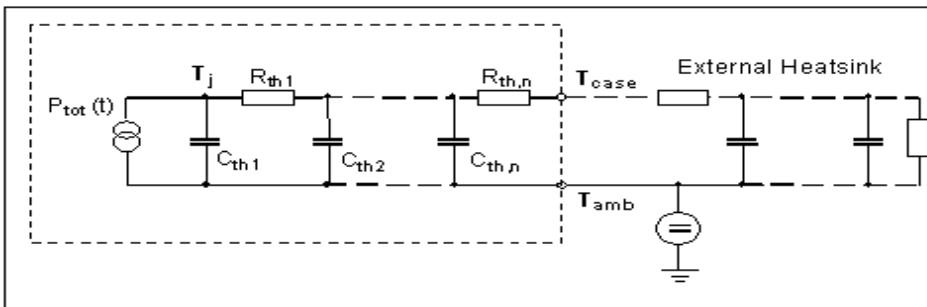

⁵⁾ C_{th6} models the additional heat capacitance of the package in case of non-ideal cooling. It is not needed if $R_{thCA}=0\text{ K/W}$.

1 Power dissipation

$$P_{TOT} = f(T_C)$$

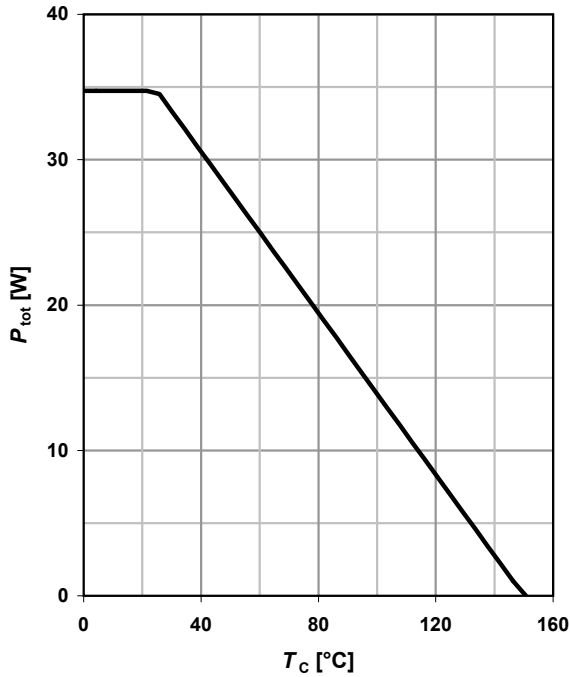

2 Safe operating area

$$I_D = f(V_{DS}); T_C = 25^\circ\text{C}; D = 0$$

parameter: t_p

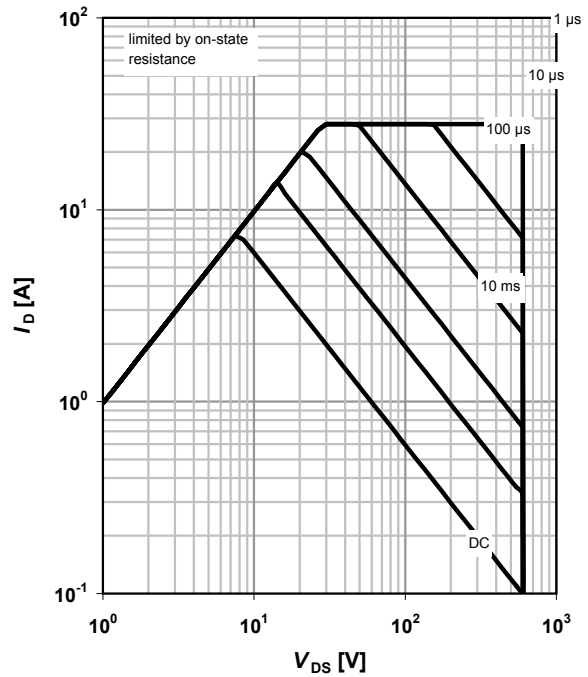

3 Max. transient thermal impedance

$$Z_{thJC} = f(t_p)$$

parameter: $D = t_p / T$

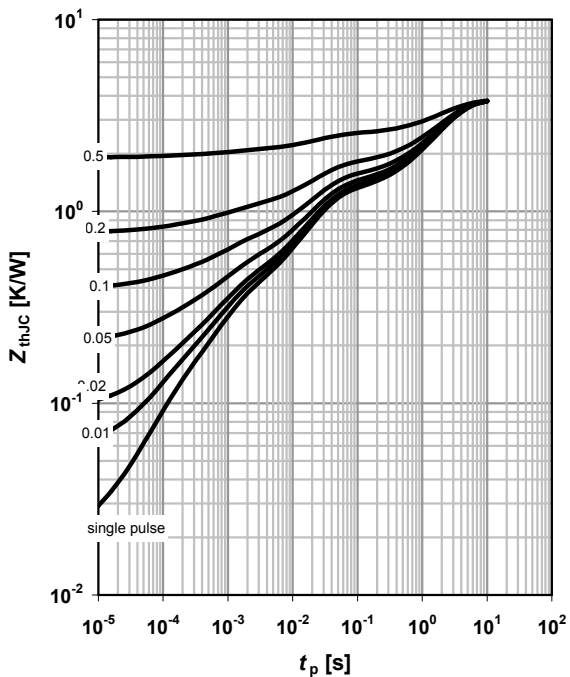

4 Typ. output characteristics

$$I_D = f(V_{DS}); T_j = 25^\circ\text{C}$$

parameter: V_{GS}

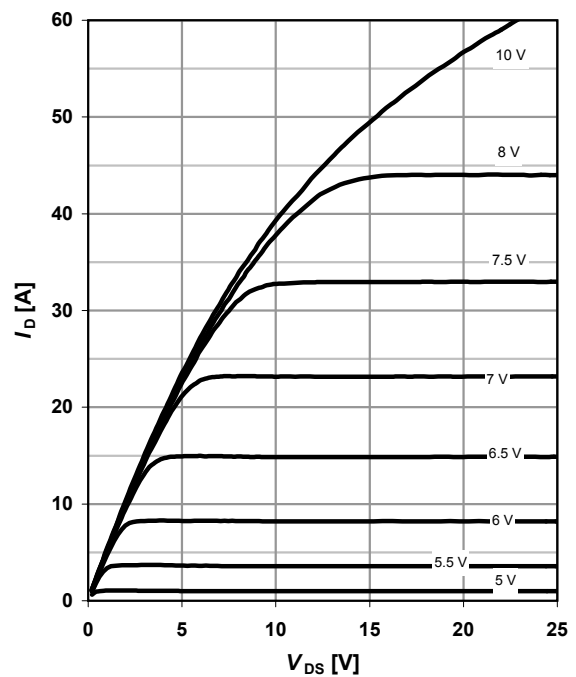

5 Typ. output characteristics

$I_D = f(V_{DS}); T_j = 150^\circ\text{C}$

parameter: V_{GS}

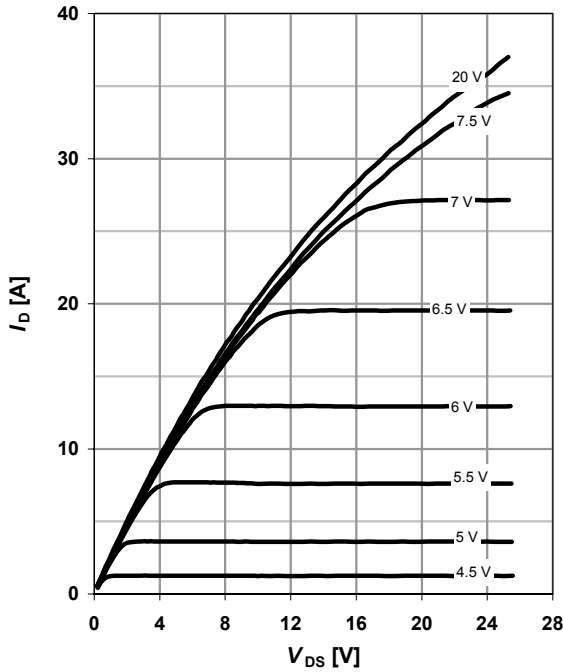

6 Typ. drain-source on-state resistance

$R_{DS(on)} = f(I_D); T_j = 150^\circ\text{C}$

parameter: V_{GS}

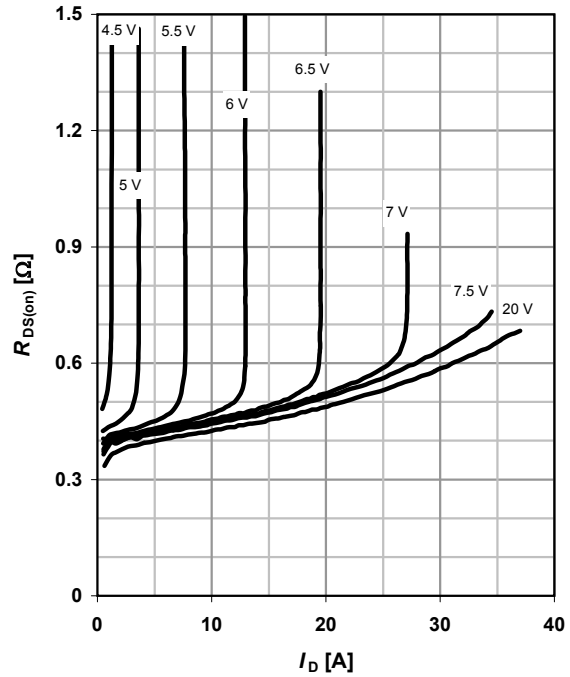

7 Drain-source on-state resistance

$R_{DS(on)} = f(T_j); I_D = 13.1\text{ A}; V_{GS} = 10\text{ V}$

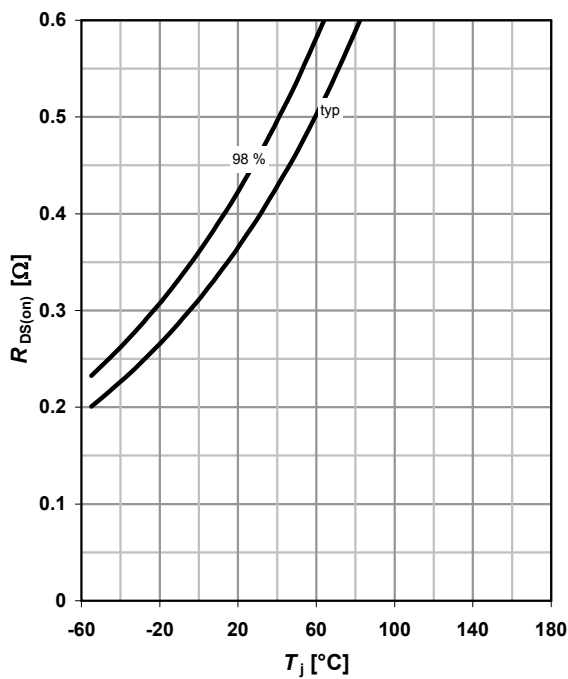

8 Typ. transfer characteristics

$I_D = f(V_{GS}); |V_{DS}| > 2I_D/R_{DS(on)max}$

parameter: T_j

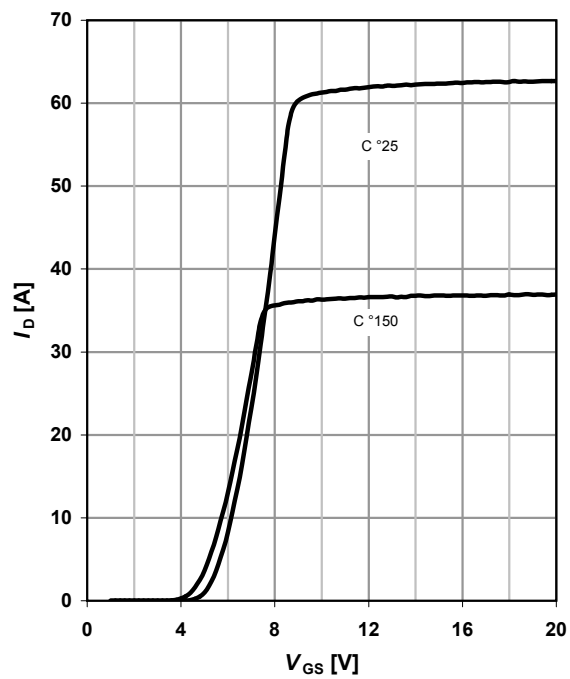

9 Typ. gate charge

$V_{GS}=f(Q_{gate}); I_D=20.7 \text{ A pulsed}$

parameter: V_{DD}

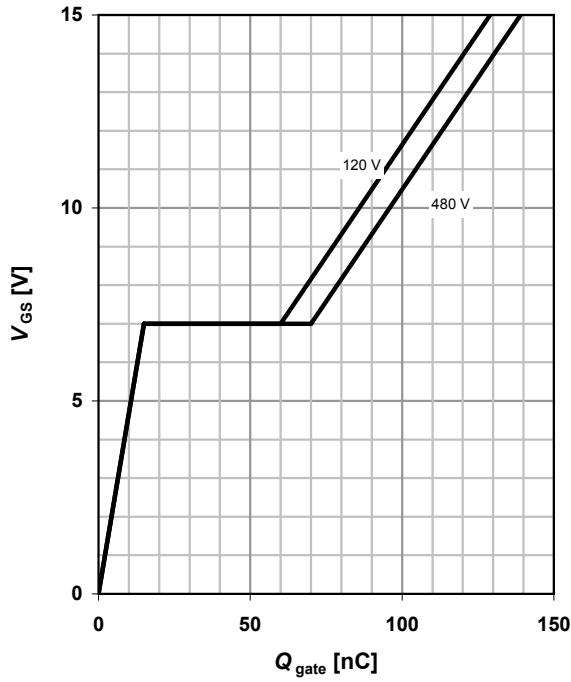

10 Forward characteristics of reverse diode

$I_F=f(V_{SD})$

parameter: T_j

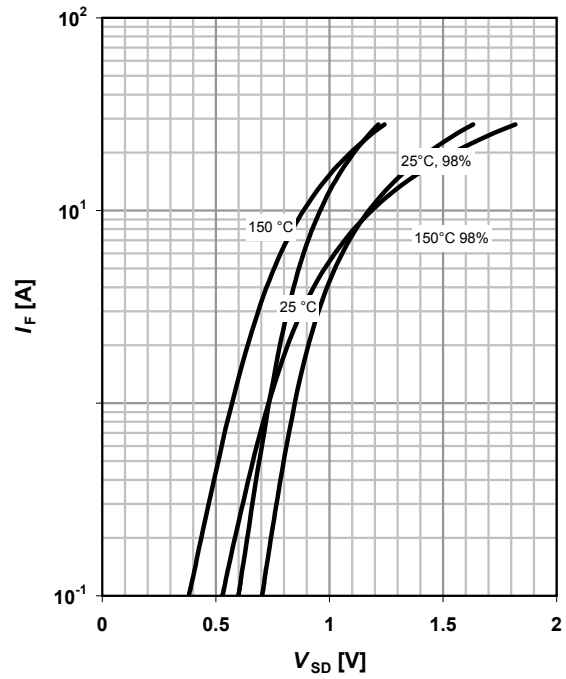

11 Avalanche SOA

$I_{AR}=f(t_{AR})$

parameter: $T_{j(start)}$

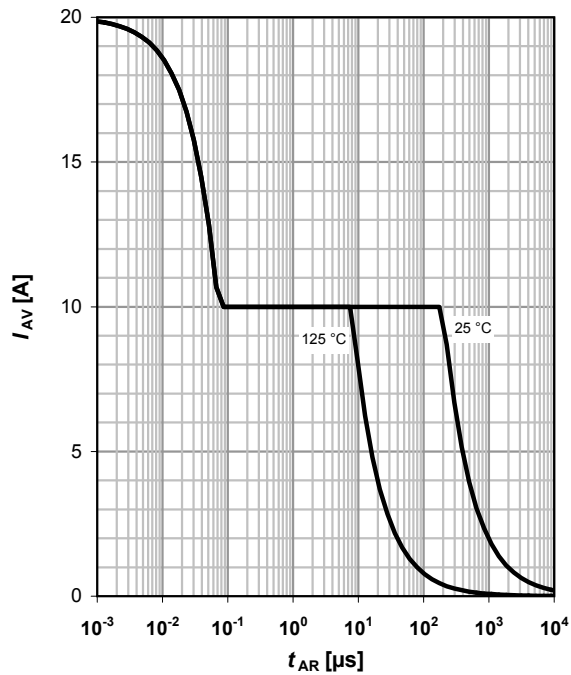

12 Avalanche energy

$E_{AS}=f(T_j); I_D=10 \text{ A}; V_{DD}=50 \text{ V}$

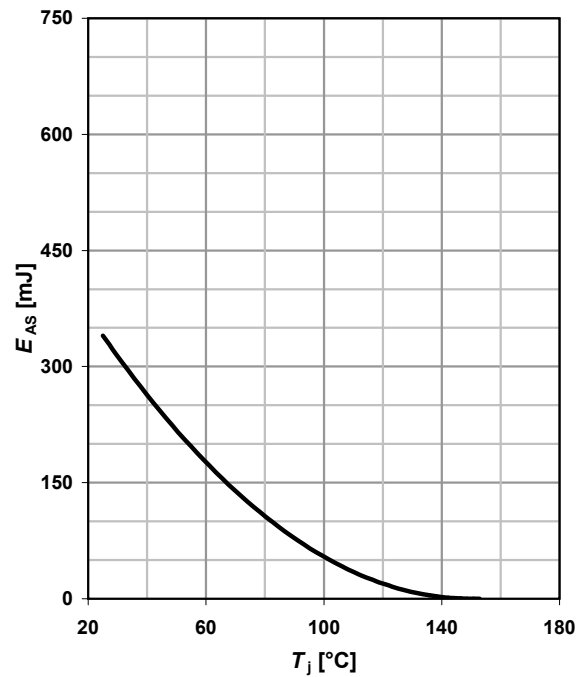

13 Drain-source breakdown voltage

$V_{BR(DSS)} = f(T_j); I_D = 10\text{mA}$

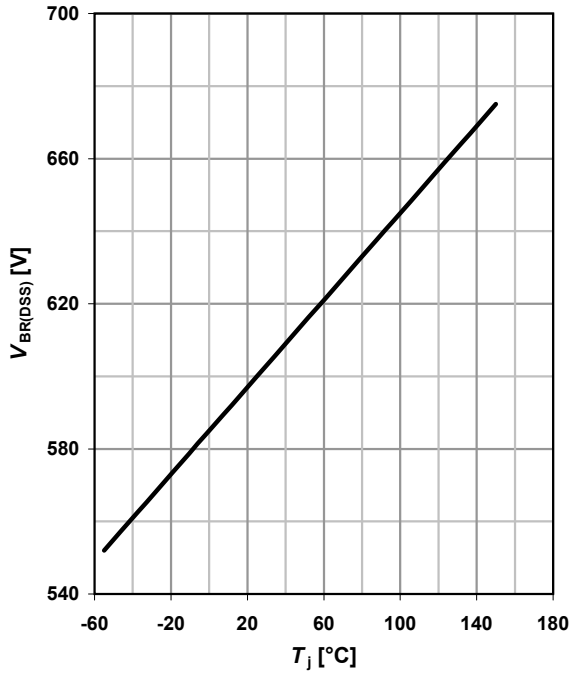

14 Typ. capacitances

$C = f(V_{DS}); V_{GS} = 0\text{ V}; f = 1\text{ MHz}$

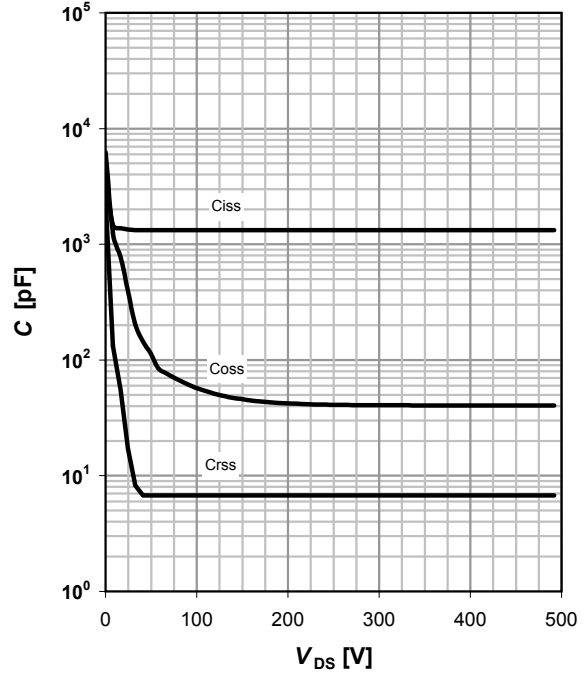

15 Typ. C_{oss} stored energy

$E_{oss} = f(V_{DS})$

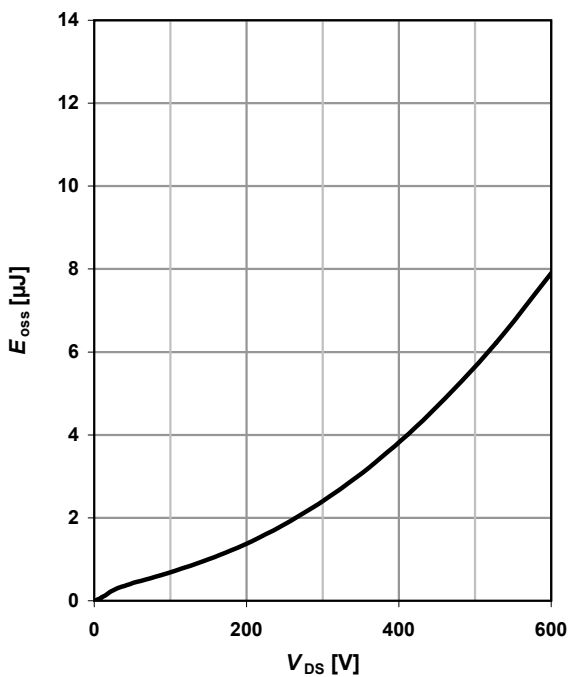

16 Typ. reverse recovery charge

$Q_{rr} = f(T_j); I_S = 20.7\text{ A}$

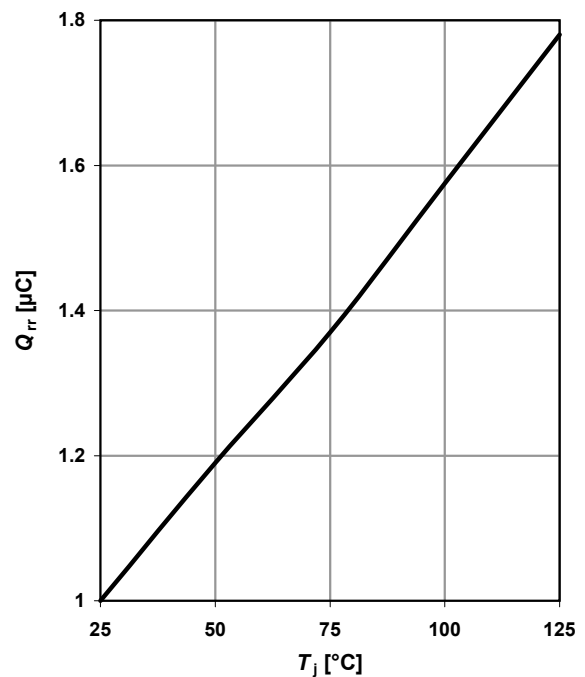

17 Typ. reverse recovery charge

$$Q_{rr} = f(I_S); di/dt = 100 \text{ A}/\mu\text{s}$$

parameter: T_j

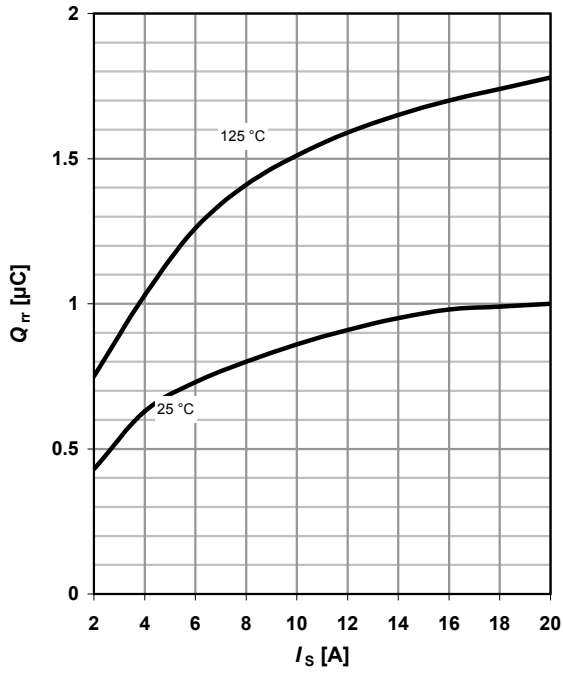

18 Typ. reverse recovery charge

$$Q_{rr} = f(di/dt); I_D = 20.7 \text{ A}$$

parameter: T_j

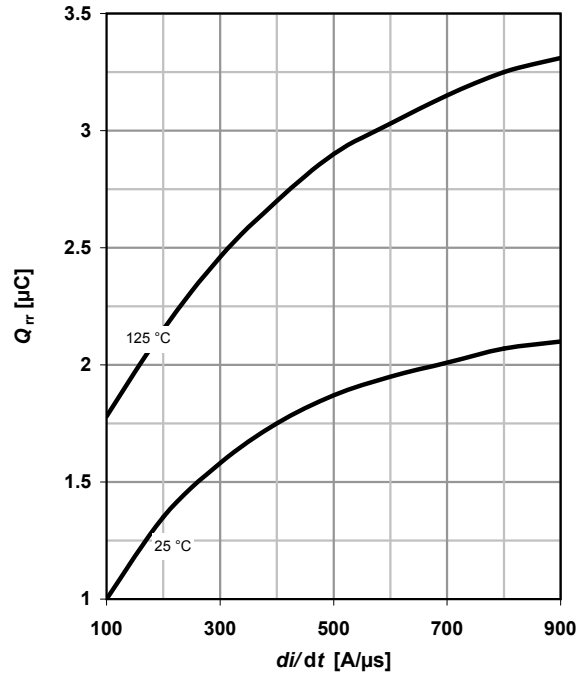

Definition of diode switching characteristics

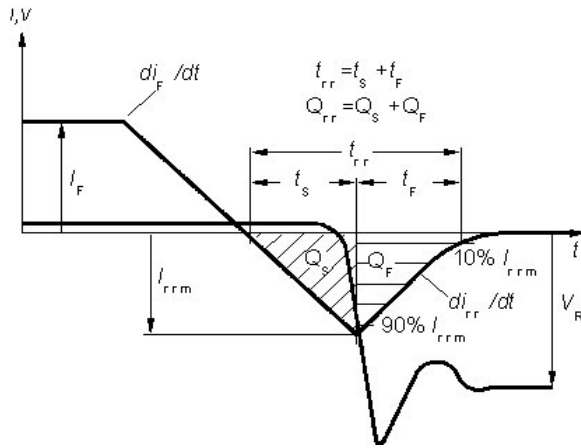

PG-TO220-3-31: Outline

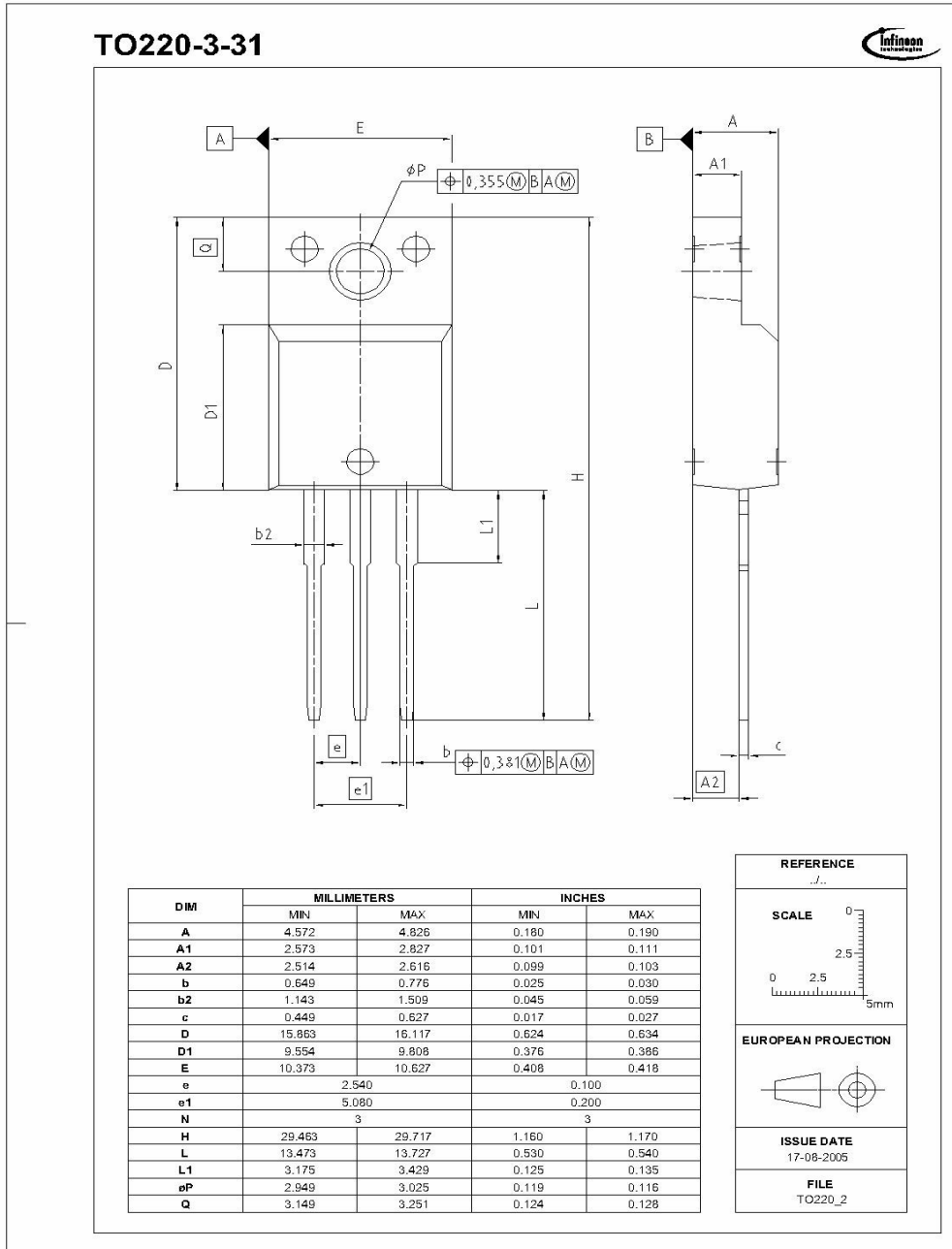

Dimensions in mm

Published by
Infineon Technologies AG
D-81726 München, Germany

© Infineon Technologies AG 2006
All Rights Reserved.

Attention please!

The information herein is given to describe certain components and shall not be considered as warranted characteristics.

Terms of delivery and rights to technical change reserved.

We hereby disclaim any and all warranties, including but not limited to warranties of non-infringement, regarding circuits, descriptions and charts stated herein.

Infineon Technologies is an approved CECC manufacturer.

Information

For further information on technology, delivery terms and conditions and prices, please contact your nearest Infineon Technologies office in Germany or our Infineon Technologies representatives worldwide (see address list).

Warnings

Due to technical requirements, components may contain dangerous substances.
For information on the types in question, please contact your nearest Infineon Technologies office.

Infineon Technologies' components may only be used in life-support devices or systems with the expressed written approval of Infineon Technologies if a failure of such components can reasonably be expected to cause the failure of that life-support device or system, or to affect the safety or effectiveness of that device or system. Life support devices or systems are intended to be implanted in the human body, or to support and/or maintain and sustain and/or protect human life. If they fail, it is reasonable to assume that the health of the user or other persons may be endangered.